



Dell™ Inspiron™ 6400/E1505 Service Manual

[Before You Begin](#)
[System Components](#)
[Optical Drive](#)
[Hard Drive](#)
[Memory Module\(s\)](#)
[Modem](#)
[Mini-Card](#)
[Internal Card With Bluetooth® Wireless Technology](#)
[Hinge Cover](#)
[Keyboard](#)
[Display Assembly](#)
[Palm Rest](#)

[Coin-Cell Battery](#)
[Speakers](#)
[Processor Thermal-Cooling Assembly](#)
[Processor Module](#)
[Video Card/Thermal-Cooling Assembly](#)
[System Fan](#)
[ExpressCard/Hard-Drive Bay Assembly](#)
[System Board](#)
[Battery Latch Assembly](#)
[Flashing the BIOS](#)
[Pin Assignments for I/O Connectors](#)

Notes, Notices, and Cautions

-  **NOTE:** A NOTE indicates important information that helps you make better use of your computer.
-  **NOTICE:** A NOTICE indicates either potential damage to hardware or loss of data and tells you how to avoid the problem.
-  **CAUTION:** A CAUTION indicates a potential for property damage, personal injury, or death.

Abbreviations and Acronyms

For a complete list of abbreviations and acronyms, see "Glossary" in the *Owner's Manual*.

If you purchased a Dell™ n Series computer, any references in this document to Microsoft® Windows® operating systems are not applicable.

Information in this document is subject to change without notice.
© 2006 Dell Inc. All rights reserved.

Reproduction in any manner whatsoever without the written permission of Dell Inc. is strictly forbidden.

Trademarks used in this text: *Dell*, the *DELL* logo, and *Inspiron* are trademarks of Dell Inc.; *Microsoft* and *Windows* are registered trademarks of Microsoft Corporation; *Bluetooth* is a registered trademark owned by Bluetooth SIG, Inc. and is used by Dell under license.

Other trademarks and trade names may be used in this document to refer to either the entities claiming the marks and names or their products. Dell Inc. disclaims any proprietary interest in trademarks and trade names other than its own.

Model PP20L

February 2006 Rev. A00

Battery Latch Assembly

Dell™ Inspiron™ 6400/E1505 Service Manual

- [Removing the Battery Latch Assembly](#)
- [Replacing the Battery Latch Assembly](#)

Removing the Battery Latch Assembly

⚠ CAUTION: Before you begin the following procedure, follow the safety instructions in the Product Information Guide.

🔌 NOTICE: To avoid electrostatic discharge, ground yourself by using a wrist grounding strap or by periodically touching an unpainted metal surface (such as the back panel) on the computer.

🔌 NOTICE: To help prevent damage to the system board, remove the main battery (see [Before Working Inside Your Computer](#)) before working inside the computer.

1. Follow the instructions in [Before Working Inside Your Computer](#).
2. Remove the hard drive (see [Removing the Hard Drive](#)).
3. Remove the hinge cover (see [Removing the Hinge Cover](#)).
4. Remove the keyboard (see [Keyboard](#)).
5. Remove the display assembly (see [Removing the Display Assembly](#)).
6. Remove the palm rest (see [Removing the Palm Rest](#)).
7. Remove the video card/thermal-cooling assembly, if present (see [Removing the Video Card/Thermal-Cooling Assembly](#)).
8. Remove the processor thermal-cooling assembly (see [Removing the Processor Thermal-Cooling Assembly](#)).
9. Remove the system board (see [Removing the System Board](#)).
10. Remove the M2 x 2.7-mm screw from the battery latch assembly.

When you remove the M2 x 2.7-mm screw, the battery latch release on the bottom of the computer will also be removed.

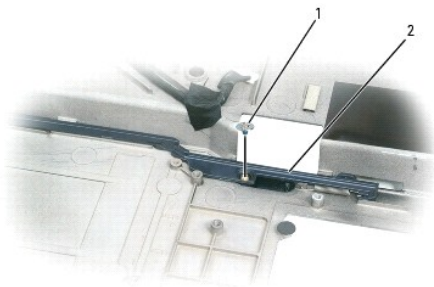

1	M2 x 2.7-mm screw	2	battery latch assembly		
---	-------------------	---	------------------------	--	--

11. Remove the spring from the hook on the computer base by lifting it away with a screwdriver or a plastic scribe.

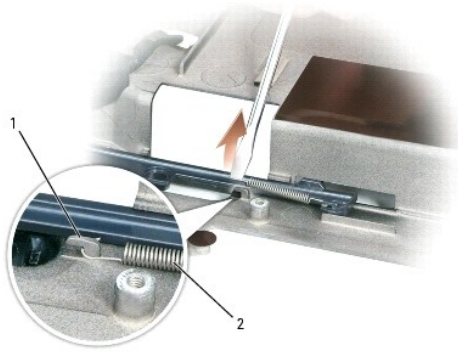

1	hook	2	spring
---	------	---	--------

12. Remove the plastic battery-latch assembly by twisting the assembly slightly and lifting it out of the channel and away from the computer base.

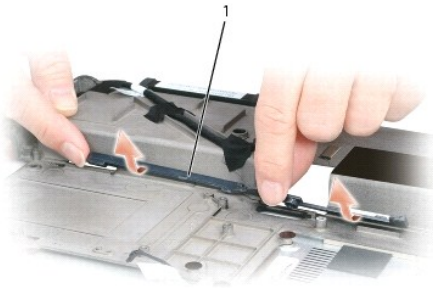

1	battery latch assembly
---	------------------------

Replacing the Battery Latch Assembly

1. Insert the latch assembly into the channel on the computer base, and press it into place.
2. Using a small screwdriver, hook the spring over the hook on the computer base.
3. Place the battery latch release under the computer base, line it up with the hole in the base, and then replace the screw in the assembly.
Ensure that the newly installed latch moves smoothly and freely when pushed and released.
4. Replace the hard drive bay and reinsert the two M3 x 3-mm screws.
5. Replace the system board and the three M2.5 x 5-mm screws.
6. Replace in reverse order the other components that you removed in [Removing the Battery Latch Assembly](#).

[Back to Contents Page](#)

[Back to Contents Page](#)

Before You Begin

Dell™ Inspiron™ 6400/E1505 Service Manual

- [Recommended Tools](#)
- [Turning Off Your Computer](#)
- [Before Working Inside Your Computer](#)
- [Computer Orientation](#)
- [Screw Identification](#)

This section provides procedures for removing and installing the components in your computer. Unless otherwise noted, each procedure assumes that the following conditions exist:

- 1 You have performed the steps in [Turning Off Your Computer](#) and [Before Working Inside Your Computer](#).
 - 1 You have read the safety information in the Dell™ *Product Information Guide*.
 - 1 A component can be replaced or—if purchased separately—installed by performing the removal procedure in reverse order.
-

Recommended Tools

The procedures in this document may require the following tools:

- 1 Small flat-blade screwdriver
 - 1 Phillips screwdriver
 - 1 Small plastic scribe
 - 1 Flash BIOS update program CD
-

Turning Off Your Computer

🔔 **NOTICE:** To avoid losing data, save and close any open files and exit any open programs before you turn off your computer.

1. Shut down the operating system:

Save and close any open files, exit any open programs, click **Start**→ **Shut Down**→ **Shut down**.

The computer turns off after the operating system shutdown process finishes.

2. Ensure that the computer and any attached devices are turned off. If your computer and attached devices did not automatically turn off when you shut down your operating system, press and hold the power button for 4 seconds.
-

Before Working Inside Your Computer

Use the following safety guidelines to help protect your computer from potential damage and to help ensure your own personal safety.

⚠ **CAUTION:** Before you begin any of the procedures in this section, follow the safety instructions in the *Product Information Guide*.

🔔 **NOTICE:** Handle components and cards with care. Do not touch the components or contacts on a card. Hold a card by its edges or by its metal mounting bracket. Hold a component such as a processor by its edges, not by its pins.

🔔 **NOTICE:** Only a certified service technician should perform repairs on your computer. Damage due to servicing that is not authorized by Dell is not covered by your warranty.

🔔 **NOTICE:** When you disconnect a cable, pull on its connector or on its pull-tab, not on the cable itself. Some cables have a connector with locking tabs; if you are disconnecting this type of cable, press in on the locking tabs before you disconnect the cable. As you pull connectors apart, keep them evenly aligned to avoid bending any connector pins. Also, before you connect a cable, ensure that both connectors are correctly oriented and aligned.

🔔 **NOTICE:** To help prevent damage to the computer, perform the following steps before you begin working inside the computer.

1. Ensure that the work surface is flat and clean to prevent the computer cover from being scratched.
2. Turn off your computer (see [Turning Off Your Computer](#)).

🔔 **NOTICE:** To disconnect a network cable, first unplug the cable from your computer and then unplug it from the network device.

3. Disconnect any telephone or network cables from the computer.

4. Disconnect your computer and all attached devices from their electrical outlets.
5. Close the display and turn the computer upside-down on a flat work surface.

NOTICE: To help prevent damage to the system board, remove the main battery before working inside the computer.

6. Remove the main battery:
 - a. Slide the battery-bay latch release on the bottom of the computer.
 - b. Remove the battery from the battery bay.

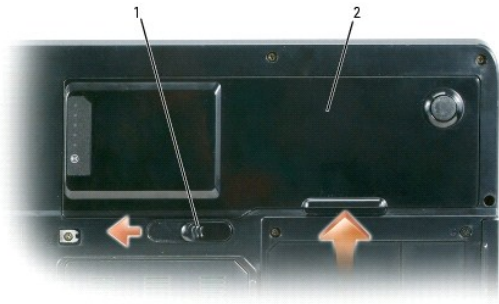

1	battery-bay latch release	2	main battery
---	---------------------------	---	--------------

7. Turn the computer top-side up.

Computer Orientation

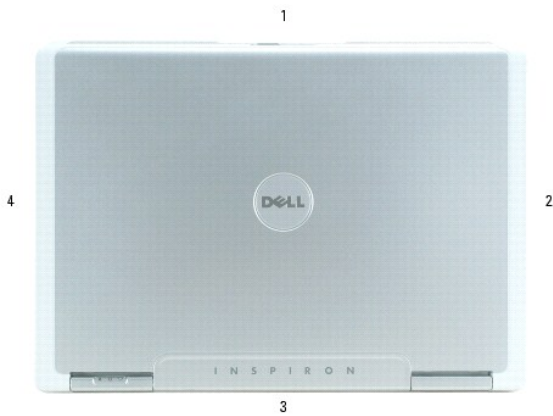







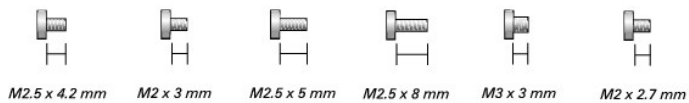







1	front	2	left	3	back
4	right				

Screw Identification

When you are removing and replacing components, print the screw identification chart as a tool to lay out and keep track of the screws. The chart provides the number of screws and their sizes.



<p>Optical Drive: (1 each)</p>  <p>M2.5 x 8 mm</p>	<p>Hard Drive: (2 each)</p>  <p>M3 x 3 mm</p>	<p>Modem: (1 each)</p>  <p>M2 x 3 mm</p>
<p>Keyboard: (2 each)</p>  <p>M2.5 x 5 mm</p>	<p>Display Assembly (bottom and back): (4 each)</p>  <p>M2.5 x 8 mm</p>	<p>Display Assembly (top): (2 each)</p>  <p>M2.5 x 5 mm</p>
<p>Display Bezel: (6 each, under rubber display bumpers)</p>  <p>M2.5 x 4.2 mm</p>	<p>Display Panel: (8 each)</p>  <p>M2 x 3 mm</p>	<p>Palm Rest: (11 each – bottom side)</p>  <p>M2.5 x 8 mm</p>
<p>Speakers: (4 total – 2 per speaker)</p>  <p>M2.5 x 5 mm</p>	<p>Fan: (4 total – 2 per fan)</p>  <p>M2.5 x 5 mm</p>	<p>System Board: (3 each)</p>  <p>M2.5 x 5 mm</p>
<p>Hard Drive Bay: (2 each)</p>  <p>M2 x 3 mm</p>	<p>Battery Latch: (1 each)</p>  <p>M2 x 2.7 mm</p>	

Internal Card With Bluetooth® Wireless Technology

Dell™ Inspiron™ 6400/E1505 Service Manual

- [Removing the Card](#)
- [Replacing the Card](#)

Removing the Card

- ⚠ **CAUTION:** Before you perform the following procedures, follow the safety instructions in the Product Information Guide.
- 🔌 **NOTICE:** To avoid electrostatic discharge, ground yourself by using a wrist grounding strap or by periodically touching an unpainted metal surface (such as the back panel) on the computer.
- 🔌 **NOTICE:** To avoid damaging the system board, you must remove the main battery (see [Before Working Inside Your Computer](#)) before you begin working inside the computer.
- 📌 **NOTE:** If you ordered an internal card with Bluetooth wireless technology with your computer, the card is already installed.

1. Follow the instructions in [Before You Begin](#).

📌 **NOTE:** Ensure that you have removed the main battery for access to the card.

2. Use a plastic scribe to pry the card door open.
3. Disconnect the card cable connector from the card, and remove the door with the card from the computer.
4. Slide the card out of the plastic brackets.



1	card door	2	card cable connector	3	internal card with Bluetooth wireless technology
4	plastic brackets (2)				





Replacing the Card

1. To replace the card, connect the card to the cable, then insert it into the compartment.
 2. Replace the card door by inserting the small center tab into the notch at the base of the compartment, and snap it into place.
 3. Replace the battery.
-

[Back to Contents Page](#)

ExpressCard/Hard-Drive Bay Assembly

Dell™ Inspiron™ 6400/E1505 Service Manual

-  **CAUTION:** Before you begin the following procedure, follow the safety instructions in the Product Information Guide.
-  **NOTICE:** To avoid electrostatic discharge, ground yourself by using a wrist grounding strap or by periodically touching an unpainted metal surface (such as the back panel) on the computer.
-  **NOTICE:** To help prevent damage to the system board, remove the main battery (see [Before Working Inside Your Computer](#)) before working inside the computer.
-  **NOTE:** You can remove the hard drive bay without removing the ExpressCard cage. The only reason for removing the ExpressCard Cage from the hard drive bay is if you are replacing an existing ExpressCard cage or hard drive bay.

1. Follow the instructions in [Before Working Inside Your Computer](#).
2. Remove the hard drive (see [Removing the Hard Drive](#)).
3. Remove the optical drive (see [Optical Drive](#)).
4. Remove the hinge cover (see [Removing the Hinge Cover](#)).
5. Remove the keyboard (see [Keyboard](#)).
6. Remove the display assembly (see [Removing the Display Assembly](#)).
7. Remove the palm rest (see [Removing the Palm Rest](#)).
8. If applicable, remove the video card/thermal-cooling assembly (see [Video Card/Thermal-Cooling Assembly](#)); otherwise, continue to step 9.
9. Remove the six M2.5x 5-mm screws from the ExpressCard/hard-drive bay assembly.

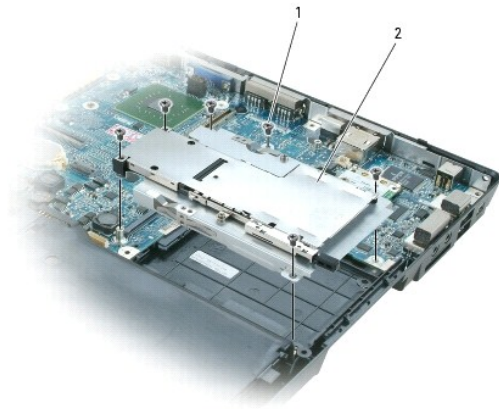

1	M2.5 x 5-mm screws (6)	2	ExpressCard/hard-drive bay assembly		
---	------------------------	---	-------------------------------------	--	--

10. Remove the assembly from the system board.

Mini-Card

Dell™ Inspiron™ 6400/E1505 Service Manual

If you ordered a Mini-Card with your computer, the card is already installed.

CAUTION: Before you begin any of the procedures in this section, follow the safety instructions in the Product Information Guide.

NOTICE: To help prevent damage to the system board, you must remove the battery from the battery bay before you begin working inside the computer.

1. Follow the procedures in [Before You Begin](#).
2. Remove the hinge cover. See [Hinge Cover](#).
3. Remove the keyboard. See [Keyboard](#).
4. If a Mini-Card is not already installed, go to [step 5](#). If you are replacing a Mini-Card, remove the existing card:
 - a. Disconnect the two antenna cables from the Mini-Card.

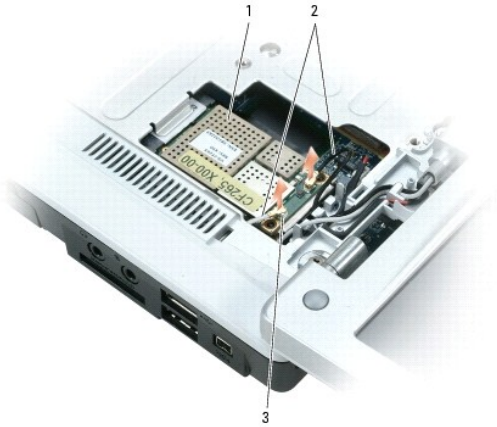

1	Mini-Card	2	antenna cables (2)	3	antenna cable connectors (2)
---	-----------	---	--------------------	---	------------------------------

- b. Release the Mini-Card by pushing the metal securing tabs toward the back of the computer until the card pops up slightly.
- c. Lift the Mini-Card out of its system board connector.



1	system board connector	2	Mini-Card	3	metal securing tabs (2)
---	------------------------	---	-----------	---	-------------------------

NOTICE: The connectors are keyed to ensure correct insertion. If you feel resistance, check the connectors on the card and on the system board, and realign the card.

5. Install the replacement Mini-Card:

- a. Insert the Mini-Card connector into the system board connector at a 45-degree angle, and then press the other end of the Mini-Card down into the securing tabs until the card clicks into place.



👉 **NOTICE:** To avoid damage to the Mini-Card, never place cables under the card.

- b. Connect the two antenna cables to the Mini-Card (black cable to the connector labeled "AUX" and the white cable to the connector labeled "MAIN").

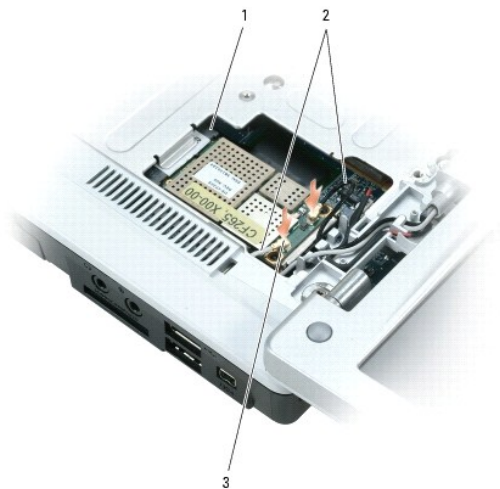

1	system board connector	2	antenna cables (2)	3	antenna cable connectors (2)
---	------------------------	---	--------------------	---	------------------------------

[Back to Contents Page](#)

Coin-Cell Battery

Dell™ Inspiron™ 6400/E1505 Service Manual

- [Removing the Coin-Cell Battery](#)
 - [Replacing the Coin-Cell Battery](#)
-

Removing the Coin-Cell Battery

- ⚠ **CAUTION:** Before you begin the following procedure, follow the safety instructions in the Product Information Guide.
 - 👉 **NOTICE:** To avoid electrostatic discharge, ground yourself by using a wrist grounding strap or by periodically touching an unpainted metal surface (such as the back panel) on the computer.
 - 👉 **NOTICE:** To help prevent damage to the system board, remove the main battery (see [Before Working Inside Your Computer](#)) before working inside the computer.
1. Follow the instructions in [Before Working Inside Your Computer](#).
 2. Remove the hinge cover (see [Removing the Hinge Cover](#)).
 3. Remove the keyboard (see [Keyboard](#)).
 4. Insert a plastic scribe into the guide on the side of the coin-cell battery compartment, and pry out the battery.



Replacing the Coin-Cell Battery

1. When you replace the battery, insert it at a 30-degree angle under the clip with the positive (identified by a plus [+] symbol) side up, and then push it into place.
 2. Replace the keyboard (see [Keyboard](#)).
 3. Replace the hinge cover (see [Replacing the Hinge Cover](#)).
-

System Components

Dell™ Inspiron™ 6400/E1505 Service Manual

- ➔ **NOTICE:** Only a certified service technician should perform repairs on your computer. Damage due to servicing that is not authorized by Dell is not covered by your warranty.
- ➔ **NOTICE:** Unless otherwise noted, each procedure in this document assumes that a part can be replaced by performing the removal procedure in reverse order.

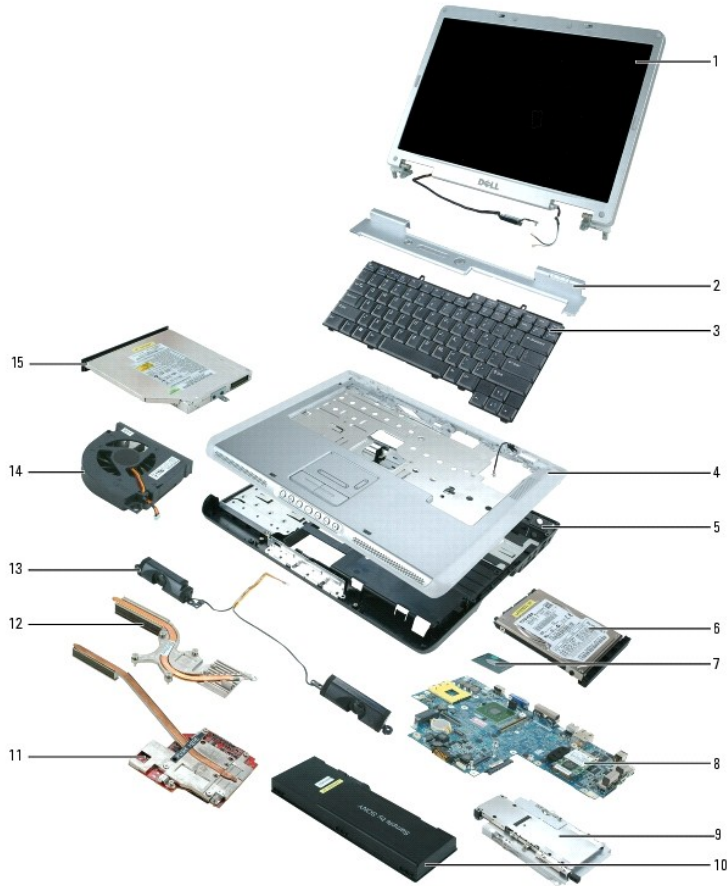

1	display assembly	2	hinge cover	3	keyboard
4	palm rest (with touch pad)	5	computer base	6	hard drive
7	processor	8	system board	9	ExpressCard/Hard-Drive Bay Assembly
10	main battery	11	video card/thermal-cooling assembly	12	processor thermal-cooling assembly
13	speakers (2)	14	fan	15	optical drive

Processor Module

Dell™ Inspiron™ 6400/E1505 Service Manual

- [Removing the Processor Module](#)
- [Replacing the Processor Module](#)

Removing the Processor Module

⚠ CAUTION: Before you begin the following procedure, follow the safety instructions in the Product Information Guide.

- ➡ **NOTICE:** To avoid electrostatic discharge, ground yourself by using a wrist grounding strap or by periodically touching an unpainted metal surface (such as the back panel) on the computer.
- ➡ **NOTICE:** Do not touch the processor die. Press and hold the processor down on the substrate on which the die is mounted while turning the cam screw to prevent intermittent contact between the cam screw and processor.
- ➡ **NOTICE:** To avoid damage to the processor, hold the screwdriver so that it is perpendicular to the processor when turning the cam screw.
- ➡ **NOTICE:** To help prevent damage to the system board, remove the main battery (see [Before Working Inside Your Computer](#)) before working inside the computer.

1. Follow the instructions in [Before Working Inside Your Computer](#).

2. Remove the hinge cover (see [Removing the Hinge Cover](#)).

3. Remove the keyboard (see [Keyboard](#)).

4. Remove the display assembly (see [Removing the Display Assembly](#)).

5. Remove the palm rest (see [Removing the Palm Rest](#)).

➡ **NOTICE:** To ensure maximum cooling for the processor, do not touch the heat transfer areas on the processor thermal-cooling assembly. The oils in your skin reduce the heat transfer capability of the thermal pads.

6. Remove the processor thermal-cooling assembly (see [Removing the Processor Thermal-Cooling Assembly](#)).

➡ **NOTICE:** When removing the processor module, pull the module straight up. Be careful not to bend the pins on the processor module.

7. To loosen the ZIF socket, use a small, flat-blade screwdriver and rotate the ZIF-socket cam screw counterclockwise until it comes to the cam stop.

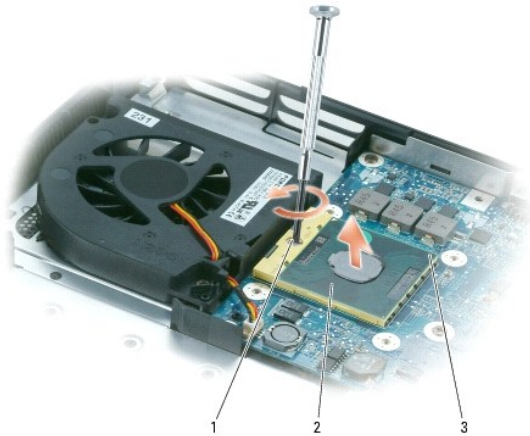

1	ZIF-socket cam screw	2	microprocessor	3	pin-1 corner of microprocessor
---	----------------------	---	----------------	---	--------------------------------

🔍 NOTE: The ZIF-socket cam screw secures the processor to the system board. Take note of the arrow on the ZIF- socket cam screw, which indicates the direction to turn the cam screw.

8. Lift the processor module from the ZIF socket.

Replacing the Processor Module

- ➔ **NOTICE:** Ensure that the cam lock is in the fully open position before seating the processor module. Seating the processor module properly in the ZIF socket does not require force.
- ➔ **NOTICE:** A processor module that is not properly seated can result in an intermittent connection or permanent damage to the processor and ZIF socket.
- 🔍 **NOTE:** If a new microprocessor is installed, you will receive one of the following: a new thermal-cooling assembly which will include an affixed thermal pad; or, you will receive a new thermal pad along with a tech sheet to illustrate proper installation.

1. Align the pin-1 corner of the processor module with the pin-1 corner of the ZIF socket, and insert the processor module.

🔍 **NOTE:** The pin-1 corner of the processor module has a triangle that aligns with the triangle on the pin-1 corner of the ZIF socket.

- ➔ **NOTICE:** You must position the processor module correctly in the ZIF socket to avoid permanent damage to the module and the socket.

When the processor module is correctly seated, all four corners are aligned at the same height. If one or more corners of the module are higher than the others, the module is not seated correctly.

2. Tighten the ZIF socket by turning the cam screw clockwise to secure the processor module to the system board.
3. Perform the steps in [Removing the Processor Module](#) in reverse order, beginning with [step 6](#).

[Back to Contents Page](#)

Processor Thermal-Cooling Assembly

Dell™ Inspiron™ 6400/E1505 Service Manual

- [Removing the Processor Thermal-Cooling Assembly](#)
- [Replacing the Processor Thermal-Cooling Assembly](#)

Removing the Processor Thermal-Cooling Assembly

- ⚠ CAUTION:** Before you begin the following procedure, follow the safety instructions in the Product Information Guide.
- 🔌 NOTICE:** To avoid electrostatic discharge, ground yourself by using a wrist grounding strap or by periodically touching an unpainted metal surface (such as the back panel) on the computer.
- 🔌 NOTICE:** To help prevent damage to the system board, remove the main battery (see [Before Working Inside Your Computer](#)) before working inside the computer.
1. Follow the instructions in [Before Working Inside Your Computer](#).
 2. Remove the hinge cover (see [Removing the Hinge Cover](#)).
 3. Remove the keyboard (see [Keyboard](#)).
 4. Remove the display assembly (see [Removing the Display Assembly](#)).
 5. Remove the palm rest (see [Removing the Palm Rest](#)).
 6. Loosen in consecutive order the four captive screws, labeled "1" through "4," that secure the processor thermal-cooling assembly to the system board.
 7. Lift the processor thermal-cooling assembly and remove it from the system board.

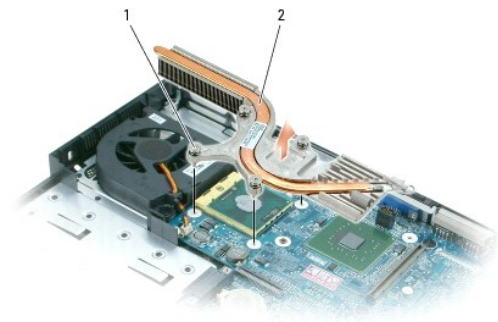

1	captive screws (4)	2	processor thermal-cooling assembly		
---	--------------------	---	------------------------------------	--	--

Replacing the Processor Thermal-Cooling Assembly

1. Place the processor thermal-cooling assembly over the processor.
2. Tighten the four captive screws, labeled "1" through "4," in consecutive order.

Display Assembly

Dell™ Inspiron™ 6400/E1505 Service Manual

- [Removing the Display Assembly](#)
- [Replacing the Display Assembly](#)
- [Display Bezel](#)
- [Display Panel](#)
- [Display Latch](#)

Removing the Display Assembly

⚠ CAUTION: Before you begin the following procedure, follow the safety instructions in the Product Information Guide.

- 🔌 **NOTICE:** To avoid electrostatic discharge, ground yourself by using a wrist grounding strap or by periodically touching an unpainted metal surface (such as the back panel) on the computer.
- 🔌 **NOTICE:** To help prevent damage to the system board, remove the main battery (see [Before Working Inside Your Computer](#)) before working inside the computer.

1. Follow the instructions in [Before Working Inside Your Computer](#).
2. Remove the hinge cover (see [Removing the Hinge Cover](#)).
3. Remove the keyboard (see [Keyboard](#)).
4. Remove the two M2.5 x 8-mm screws from the bottom of the display.

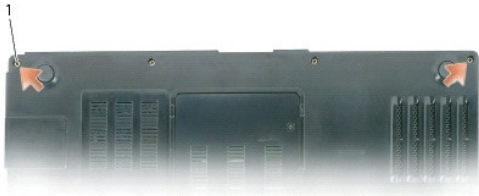

1	M2.5 x 8-mm screws (2)				
---	------------------------	--	--	--	--

5. Remove the two screw covers from the back of the computer; then, remove the two M2.5 x 8-mm screws from the back of the computer.



1	M2.5 x 8-mm screws (2)				
---	------------------------	--	--	--	--

6. Remove the two M2.5 x 5-mm screws from the top side of the computer.
7. Disconnect the antenna cables from the Mini-Card.
8. Loosen the captive grounding-wire screw.
9. Disconnect the display cable, using the pull-tab.
10. Dislodge the display cable from the display cable channel.

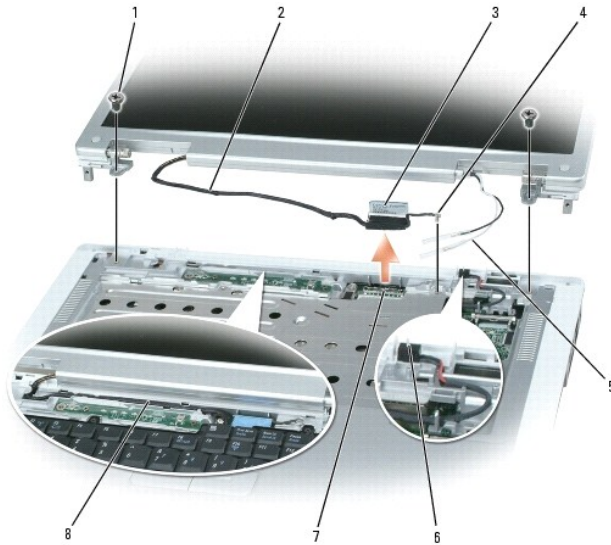

1	M2.5 x 5-mm screws (2)	4	grounding-wire screw	7	display cable connector on system board
2	display cable	5	antenna cables	8	display cable channel
3	display cable pull-tab	6	standby switch		

11. Lift the display up and away from the computer.

NOTICE: The standby switch is fragile and easily broken. Avoid knocking the switch when removing and replacing the display.

Replacing the Display Assembly

1. Ensure the display cable is lying flat in the display cable channel and securely tucked underneath the tabs before sliding the display onto the computer base.

NOTE: Ensure the antenna cables are not twisted and that they are lying flat in the antenna cable clip.

2. Replace the two M2.5 x 5-mm screws in the top side of the computer.

3. Connect the display cable to the system board.

4. Reroute the display cable into the cable channel.

5. Replace the two M2.5 x 8-mm screws in the back of the computer and replace the two screw covers.

6. Replace the two M2.5 x 8-mm screws in the bottom of the computer.

7. Replace the hinge cover (see [Replacing the Hinge Cover](#)).

8. If a Mini-Card is installed, connect the antenna cables to the card (see [Mini-Card](#)). If one is not installed, tuck the antenna cables into their secured location.

9. Replace the Mini-Card cover.

Display Bezel

Removing the Display Bezel

CAUTION: Before you begin the following procedure, follow the safety instructions in the Product Information Guide.

- 🔗 **NOTICE:** To avoid electrostatic discharge, ground yourself by using a wrist grounding strap or by periodically touching an unpainted metal surface (such as the back panel) on the computer.
- 🔗 **NOTICE:** To help prevent damage to the system board, you must remove the main battery (see [Before Working Inside Your Computer](#)) before you begin working inside the computer.

1. Follow the instructions in [Before Working Inside Your Computer](#).
2. Remove the display assembly (see [Removing the Display Assembly](#)).
3. Remove the six rubber display bumpers.
4. Remove the six M2.5 x 4.2-mm screws around the display bezel.

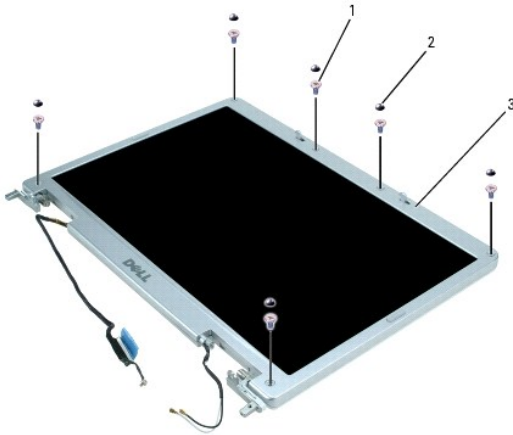

1	M2.5 x 4.2-mm screws(6)	2	rubber display bumpers (6)	3	display bezel
---	-------------------------	---	----------------------------	---	---------------

- 🔗 **NOTICE:** Removal of the bezel from the display back cover requires extreme care to avoid damage to the bezel.

5. Use your fingers to separate the bezel from the display back cover by pulling the lower-right corner of the bezel down toward the bottom edge of the display assembly to clear the tab on the bottom of the lower-right corner. Then pull the bezel toward the right side of the display assembly to clear the tab on the side of the lower-right corner. Continue this motion until you have cleared all sides of the display bezel.





1	display bezel	2	display panel
---	---------------	---	---------------

Replacing the Display Bezel

1. Starting at any corner, use your fingers to gently snap the bezel into place to secure it to the display panel.
 2. Replace the six M2.5 x 4.2-mm screws around the display bezel.
 3. Replace the six rubber display bumpers around the display bezel.
-

Display Panel

Removing the Display Panel

-  **CAUTION:** Before you begin the following procedure, follow the safety instructions in the Product Information Guide.
-  **NOTICE:** To avoid electrostatic discharge, ground yourself by using a wrist grounding strap or by touching an unpainted metal surface on the computer.
-  **NOTICE:** To help prevent damage to the system board, you must remove the main battery (see [Before Working Inside Your Computer](#)) before you begin working inside the computer.

1. Follow the instructions in [Before Working Inside Your Computer](#).
2. Remove the display assembly (see [Removing the Display Assembly](#)).
3. Remove the display bezel (see [Removing the Display Bezel](#)).
4. Remove the eight M2 x 3-mm screws (four on each side of the display panel).
5. Lift the display panel out of the display back cover.

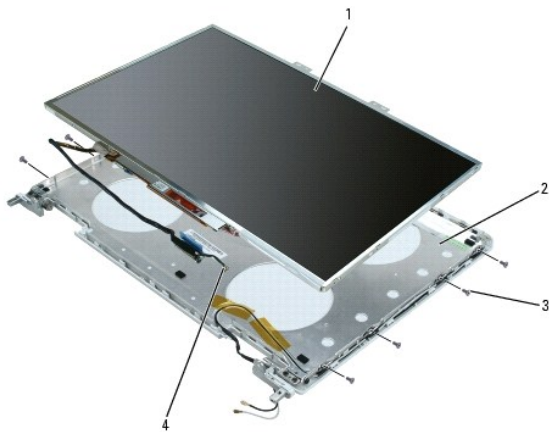

1	display panel	2	M2 x 3-mm screws (8)	3	display back cover
4	grounding wire and captive screw				

6. Press in both sides of the top flex-cable connector, and pull the top flex-cable connector away from the display connector.
7. Use the pull-tab to disconnect the bottom flex-cable connector from the inverter connector.

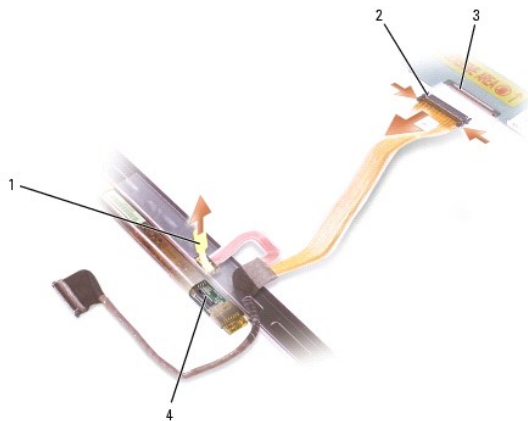

1	pull-tab on bottom flex-cable connector	2	top flex-cable connector	3	display cable connector
---	---	---	--------------------------	---	-------------------------

4	inverter connector				
---	--------------------	--	--	--	--

Replacing the Display Panel

1. Reconnect the top display-cable connector to the top flex-cable connector.
2. Reconnect the bottom flex-cable connector to the inverter connector.
3. Replace the display panel inside the display back cover.

 **NOTE:** The eight screw locations are numbered. Replace the screws in sequential order.

4. Replace the eight M2 x 3-mm screws (four on each side) in order around the display panel.
5. Replace the display bezel (see [Replacing the Display Bezel](#)).

Display Latch

Removing the Display Latch

 **CAUTION:** Before you begin the following procedure, follow the safety instructions in the Product Information Guide.

 **NOTICE:** To avoid electrostatic discharge, ground yourself by using a wrist grounding strap or by touching an unpainted metal surface on the computer.

 **NOTICE:** To help prevent damage to the system board, you must remove the main battery (see [Before Working Inside Your Computer](#)) before you begin working inside the computer.

1. Follow the instructions in [Before Working Inside Your Computer](#).
2. Remove the display assembly (see [Removing the Display Assembly](#)).
3. Remove the display bezel (see [Removing the Display Bezel](#)).
4. Slide the latch to the right and gently lift.
5. Remove the spring that attaches the latch to the display panel.

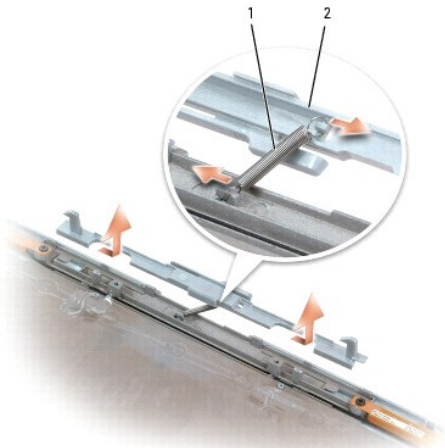

1	spring	2	display latch
---	--------	---	---------------



Replacing the Display Latch

1. Replace the spring that attaches the latch to the display panel.
 2. Align the latch with the display panel and slide the latch to the left to secure it into place.
-

[Back to Contents Page](#)

System Fan

Dell™ Inspiron™ 6400/E1505 Service Manual

-  **CAUTION:** Before you begin the following procedure, follow the safety instructions in the Product Information Guide.
-  **NOTICE:** To avoid electrostatic discharge, ground yourself by using a wrist grounding strap or by periodically touching an unpainted metal surface (such as the back panel) on the computer.
-  **NOTICE:** To help prevent damage to the system board, remove the main battery (see [Before Working Inside Your Computer](#)) before working inside the computer.

1. Follow the instructions in [Before Working Inside Your Computer](#).
2. Remove the hinge cover (see [Removing the Hinge Cover](#)).
3. Remove the keyboard (see [Keyboard](#)).
4. Remove the display assembly (see [Removing the Display Assembly](#)).
5. Remove the palm rest (see [Removing the Palm Rest](#)).
6. Remove the two M2.5 x 5-mm screws from the fan, and then remove the connector that connects the fan to the system board.

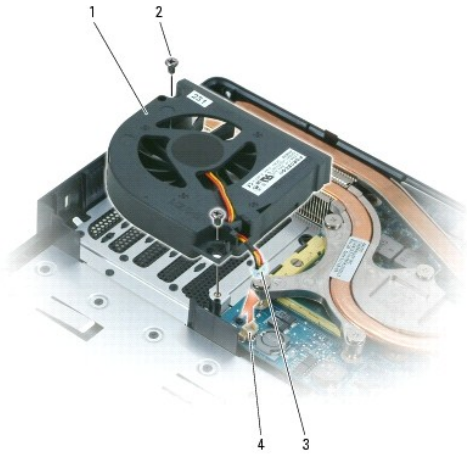

1	fan	2	M2.5 x 5-mm screws (2)	3	fan cable connector
4	fan system board connector				

Flashing the BIOS

Dell™ Inspiron™ 6400/E1505 Service Manual

 **NOTICE:** Plug the AC adapter into a known good power source to prevent a loss of power. Failure to do so may cause system damage.

1. Ensure that the AC adapter is plugged in and that the main battery is installed properly.

 **NOTE:** If you use a BIOS update program CD to flash the BIOS, press <F12> before inserting the CD so that you can set up the computer to boot from a CD this one time only. Otherwise, you must enter the system setup program to change the default boot order.

2. Insert the BIOS update program CD, and turn on the computer.

 **NOTICE:** Do not interrupt this process once it begins. Doing so may cause system damage.

Follow the instructions that appear on the screen. The computer continues to boot and updates the new BIOS. When the flash update is complete, the computer will automatically reboot.

3. Press <F2> during POST to enter the system setup program.
4. Press <Alt> and <f> to reset the computer defaults.
5. Press <Esc>, select **Save changes and reboot**, and press <Enter> to save configuration changes.
6. Remove the flash BIOS update program CD from the drive and restart the computer.

Hard Drive

Dell™ Inspiron™ 6400/E1505 Service Manual

- [Removing the Hard Drive](#)
- [Replacing the Hard Drive](#)
- [Returning a Hard Drive to Dell](#)

Removing the Hard Drive

- ⚠ **CAUTION:** If you remove the hard drive from the computer when the drive is hot, do not touch the metal housing of the hard drive.
- ⚠ **CAUTION:** Before you begin the following procedure, follow the safety instructions in the Product Information Guide.
- ➡ **NOTICE:** To help prevent damage to the system board, remove the main battery (see [Before Working Inside Your Computer](#)) before working inside the computer.
- ➡ **NOTICE:** To prevent data loss, turn off your computer before removing the hard drive. Do not remove the hard drive while the computer is on, in standby mode, or in hibernate mode.
- ➡ **NOTICE:** Hard drives are extremely fragile; even a slight bump can damage the drive.
- 📌 **NOTE:** Dell does not guarantee compatibility or provide support for hard drives from sources other than Dell.

1. Follow the instructions in [Before Working Inside Your Computer](#).
2. Turn the computer upside-down and remove the two M3 x 3-mm screws.

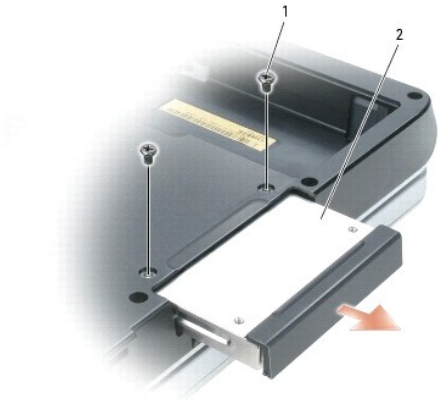

1	M3 x 3-mm screws (2)	2	hard drive		
---	----------------------	---	------------	--	--

- ➡ **NOTICE:** When the hard drive is not in the computer, store it in protective antistatic packaging. See "Protecting Against Electrostatic Discharge" in your Product Information Guide.

3. Slide the hard drive out of the computer.

Replacing the Hard Drive

- ➡ **NOTICE:** Use firm and even pressure to slide the drive into place. If you use excessive force, you may damage the connector.

1. Slide the drive into the bay until it is fully seated.
2. Replace and tighten the screws.
3. If you have installed a replacement hard drive, reinstall the Microsoft® Windows® operating system. For instructions, see "Restoring Your Operating System" in the *Owner's Manual*.
4. Reinstall drivers on the new hard drive. For instructions, see "Reinstalling Drivers and Utilities" in the *Owner's Manual*.

Returning a Hard Drive to Dell

Return your old hard drive to Dell in its original or comparable foam packaging. Otherwise, the hard drive may be damaged in transit.

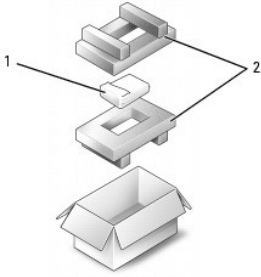

1	hard drive	2	foam packaging
---	------------	---	----------------

[Back to Contents Page](#)

Hinge Cover

Dell™ Inspiron™ 6400/E1505 Service Manual

- [Removing the Hinge Cover](#)
- [Replacing the Hinge Cover](#)

Removing the Hinge Cover

- ⚠ **CAUTION:** Before you begin the following procedure, follow the safety instructions in the Product Information Guide.
- ➡ **NOTICE:** To avoid electrostatic discharge, ground yourself by using a wrist grounding strap or by periodically touching an unpainted metal surface (such as the back panel) on the computer.
- ➡ **NOTICE:** To help prevent damage to the system board, remove the main battery (see [Before Working Inside Your Computer](#)) before working inside the computer.
- ➡ **NOTICE:** The hinge cover is fragile and can be damaged if extreme force is used. Be careful when removing the hinge cover.

1. Follow the instructions in [Before Working Inside Your Computer](#).

- ➡ **NOTICE:** To help avoid damage to the hinge cover, ensure that it is snapped securely into place before you rotate the display open to 180 degrees.

2. Open the display all the way (180 degrees) so that it lies flat against your work surface.
3. Using a small flat-blade screwdriver, insert the screwdriver on the right side to gently pry the hinge cover loose.
4. Pulling up from right to left, remove the hinge cover.

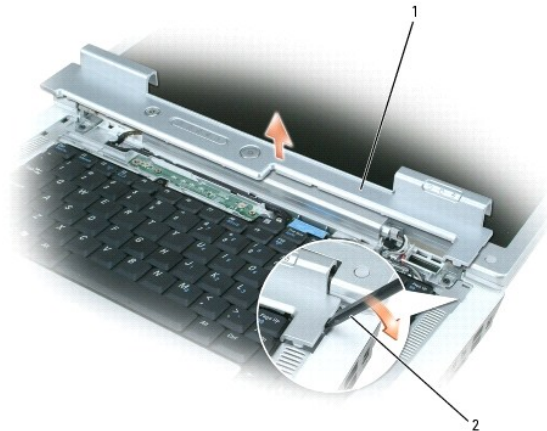

1	hinge cover	2	scribe		
---	-------------	---	--------	--	--

5. Disconnect your computer and all attached devices from their electrical outlets.

Replacing the Hinge Cover

With the display open all the way (180 degrees) so that it lies flat against the work surface, snap the cover back into place, starting from left to right.

Keyboard

Dell™ Inspiron™ 6400/E1505 Service Manual

⚠ CAUTION: Before you begin the following procedure, follow the safety instructions in the Product Information Guide.

➡ NOTICE: To avoid electrostatic discharge, ground yourself by using a wrist grounding strap or by periodically touching an unpainted metal surface (such as the back panel) on the computer.

➡ NOTICE: To help prevent damage to the system board, remove the main battery (see [Before Working Inside Your Computer](#)) before working inside the computer.

1. Follow the procedures in [Before You Begin](#).
2. Open the display.
3. Remove the hinge cover. See [Hinge Cover](#).
4. Remove the keyboard:
 - a. Remove the two M2.5 x 5-mm screws at the top of the keyboard.

➡ NOTICE: The keycaps on the keyboard are fragile, easily dislodged, and time-consuming to replace. Be careful when removing and handling the keyboard.

- b. Carefully rotate the keyboard forward to allow access to the keyboard connector.
- c. To release the keyboard cable from the keyboard connector on the system board, rotate the plastic bar on the keyboard connector toward the front of the computer.



1	M2.5 x 5-mm screws (2)	3	plastic bar on keyboard connector	5	keyboard
2	keyboard cable	4	tabs		

➡ NOTICE: To avoid scratching the palm rest when replacing the keyboard, hook the tabs along the front edge of the keyboard into the palm rest, and then press on the right edge near the top to snap the keyboard into place before replacing the two screws.

Memory Module(s)

Dell™ Inspiron™ 6400/E1505 Service Manual

- [Removing the Memory Module\(s\)](#)
- [Replacing the Memory Module\(s\)](#)

Removing the Memory Module(s)

- ⚠ **CAUTION:** Before you begin the following procedure, follow the safety instructions in the Product Information Guide.
- ➡ **NOTICE:** To prevent static damage to components inside your computer, discharge static electricity from your body before you touch any of your computer's electronic components. You can do so by touching an unpainted metal surface.
- ➡ **NOTICE:** To help prevent damage to the system board, you must remove the main battery (see [Before Working Inside Your Computer](#)) before you begin working inside the computer.
- 🔧 **NOTE:** Memory modules purchased from Dell are covered under your computer warranty.
- 🔧 **NOTE:** To get maximum performance/dual-channel memory bandwidth capability, both memory module connectors must contain memory modules and the modules must be of the same size and configuration.

1. Follow the instructions in [Before Working Inside Your Computer](#).
2. Turn the computer upside-down, loosen the two captive screws on the memory module cover, and remove the cover.



- ➡ **NOTICE:** To prevent damage to the memory module connector, do not use tools to spread the securing clips that secure the memory module.
- ➡ **NOTICE:** Handle memory modules by their edges, and do not touch the components on a module.

3. Use your fingertips to carefully spread apart the securing clips on each end of the memory module connector until the module pops up.
4. Remove the module from the connector at a 45-degree angle.

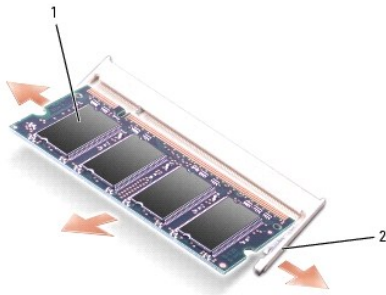

1	memory module	2	securing clips (2)
---	---------------	---	--------------------

Replacing the Memory Module(s)

 **NOTE:** To get maximum performance/dual-channel memory bandwidth capability, both memory module connectors must contain memory modules and the modules must be of the same size and configuration.

 **NOTE:** If a memory module is not installed properly, the computer does not boot.

1. Ground yourself and install the new memory module:
 - a. Align the notch in the module edge connector with the tab in the connector slot.
 - b. Slide the module firmly into the slot at a 45-degree angle, and rotate the module down until it clicks into place. If you do not feel the click, remove the module and reinstall it.

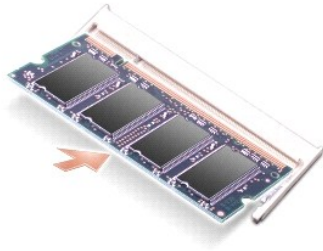

2. Replace the memory module cover and tighten the captive screws.

 **NOTICE:** If the memory module cover is difficult to close, remove the module and reinstall it. Forcing the cover to close may damage your computer.

3. Insert the battery into the battery bay, or connect the AC adapter to your computer and an electrical outlet.
4. Turn on the computer.

As the computer boots, it detects the additional memory and automatically updates the system configuration information.

[Back to Contents Page](#)

Modem

Dell™ Inspiron™ 6400/E1505 Service Manual

- [Removing the Modem](#)
- [Replacing the Modem](#)

Removing the Modem

- ⚠ CAUTION:** Before you begin the following procedure, follow the safety instructions in the Product Information Guide.
- 🔌 NOTICE:** To avoid electrostatic discharge, ground yourself by using a wrist grounding strap or by periodically touching an unpainted metal surface (such as the back panel) on the computer.
- 🔌 NOTICE:** To help prevent damage to the system board, you must remove the main battery (see [Before Working Inside Your Computer](#)) before you begin working inside the computer.
1. Follow the instructions in [Before Working Inside Your Computer](#).
 2. Turn the computer upside-down, loosen the two captive screws on the cover, and remove the cover from the computer.



3. Remove the M2 x 3-mm screw that attaches the modem to the system board.
4. Pull up on the pull-tab to disconnect the modem from the modem connector on the system board.

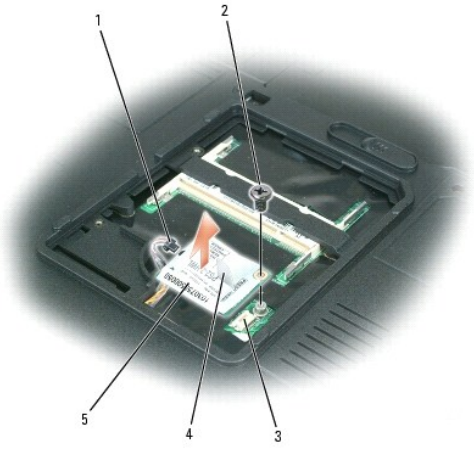

1	modem connector on system board	2	pull-tab	3	modem
4	modem cable	5	M2 x 3-mm screw		

 **NOTICE:** Do not disconnect the modem cable from the system board.

5. Disconnect the modem cable from the modem.
-

Replacing the Modem

1. Connect the modem cable to the modem.

 **NOTICE:** Ensure that the modem cable is routed correctly when you replace the modem.

2. Connect the modem to the system board.

Align the connector on the bottom of the modem with the modem connector on the system board, and press down on the right side of the modem.

3. Replace the M2 x 3-mm screw.
-

[Back to Contents Page](#)

Optical Drive

Dell™ Inspiron™ 6400/E1505 Service Manual

Your computer ships with a fixed optical drive installed.

⚠ CAUTION: Before you begin any of the procedures in this section, follow the safety instructions in the Product Information Guide.

🔄 NOTICE: To help prevent damage to drives, store them in a safe, dry place when they are not installed in the computer. Avoid pressing down on them or placing heavy objects on top of them.

1. Follow the instructions in [Before Working Inside Your Computer](#).
2. Turn the computer upside-down and remove the M2.5 x 8-mm device security screw labeled with a lock icon (🔒).
3. Insert a screwdriver into the indentation for the device security screw, and push the notch on the metal tab toward the media bay to release the optical drive from the media bay.

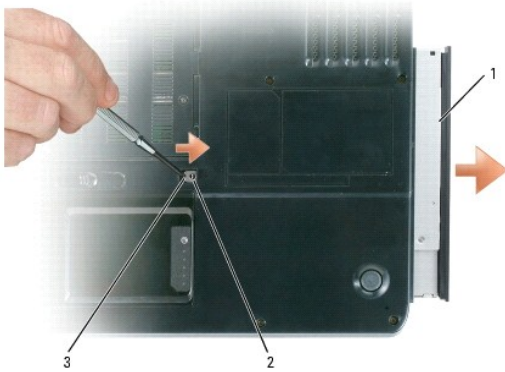

1	optical drive in media bay	2	indentation for M2.5 x 8-mm device security screw	3	notch
---	----------------------------	---	---	---	-------

4. Pull the drive out of the media bay.

Palm Rest

Dell™ Inspiron™ 6400/E1505 Service Manual

- [Removing the Palm Rest](#)
- [Replacing the Palm Rest](#)

Removing the Palm Rest

- ⚠ **CAUTION:** Before you begin the following procedure, follow the safety instructions in the Product Information Guide.
- 🔌 **NOTICE:** To avoid electrostatic discharge, ground yourself by using a wrist grounding strap or by periodically touching an unpainted metal surface (such as the back panel) on the computer.
- 🔌 **NOTICE:** To help prevent damage to the system board, remove the main battery (see [Before Working Inside Your Computer](#)) before working inside the computer.

1. Follow the instructions in [Before Working Inside Your Computer](#).
2. Remove the optical drive (see [Optical Drive](#)).
3. Remove the hinge cover (see [Removing the Hinge Cover](#)).
4. Remove the keyboard (see [Keyboard](#)).
5. Remove the display assembly (see [Removing the Display Assembly](#)).
6. Remove the eleven remaining 2.5 x 8-mm screws from the bottom of the computer.

🔧 **NOTE:** The screw locations may vary slightly from the image shown below.



1	2.5 x 8-mm screws (11)				
---	------------------------	--	--	--	--

7. Turn the computer top-side up and loosen the palm -rest captive screw.

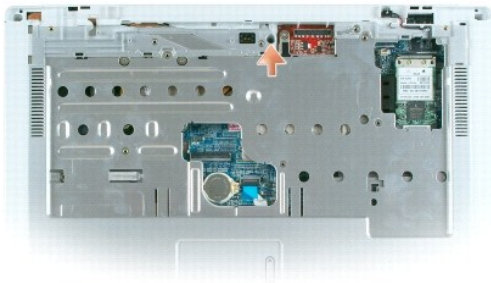

8. Disconnect the touch pad connector and the standby switch connector from the system board.

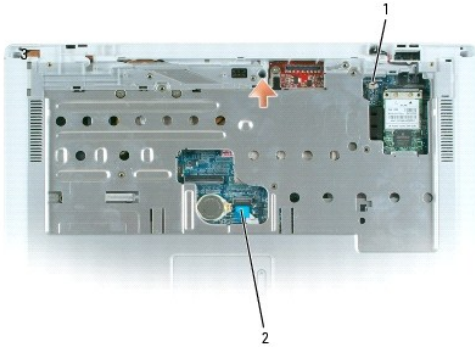

1	standby switch connector				
2	touch pad connector				

9. Lift the palm rest and remove it from the computer.



Replacing the Palm Rest

1. Align the palm rest with the bottom plastics and gently snap it into place.
2. Reconnect the touch-pad connector and the standby switch connector to the system board.
3. Tighten the palm -rest captive screw.
4. Turn the computer upside-down, and replace the eleven M2.5 x 8-mm screws on the bottom of the computer.
5. Replace the display assembly (see [Replacing the Display Assembly](#)).
6. Replace the keyboard (see [Keyboard](#)).
7. Replace the hinge cover (see [Replacing the Hinge Cover](#)).

Pin Assignments for I/O Connectors

Dell™ Inspiron™ 6400/E1505 Service Manual

- [USB Connector](#)
 - [Video Connector](#)
 - [S-Video TV-Out Connector](#)
 - [IEEE 1394 Connector](#)
-

USB Connector

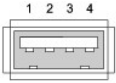

Pin	Signal
1	USB5V+
2	USBP-
3	USBP+
4	GND

Video Connector

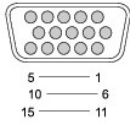

Pin	Signal	Pin	Signal
1	CRT_R	9	5V+
2	CRT_G	10	GND
3	CRT_B	11	MONITOR_DETECT-
4	NC	12	DDC_DATA
5	GND	13	CRT_HS
6	GND	14	CRT_VS
7	GND	15	DDC_CLK
8	GND		

S-Video TV-Out Connector

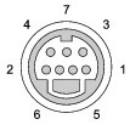

S-Video	
Pin	Signal
1	GND

2	GND
3	DLUMA-L
4	DCRMA-L

Composite Video	
Pin	Signal
5	NC
6	DCMPS-L
7	GND

IEEE 1394 Connector

1 2 3 4



Pin	Signal
1	TPB-
2	TPB+
3	TPA-
4	TPA+

[Back to Contents Page](#)

Speakers

Dell™ Inspiron™ 6400/E1505 Service Manual

- [Removing the Speakers](#)
- [Replacing the Speakers](#)

Removing the Speakers

- ⚠ CAUTION:** Before you begin the following procedure, follow the safety instructions in the Product Information Guide.
- 🔧 NOTICE:** To avoid electrostatic discharge, ground yourself by using a wrist grounding strap or by periodically touching an unpainted metal surface (such as the back panel) on the computer.
- 🔧 NOTICE:** To help prevent damage to the system board, remove the main battery (see [Before Working Inside Your Computer](#)) before working inside the computer.
1. Follow the instructions in [Before Working Inside Your Computer](#).
 2. Remove the hinge cover (see [Removing the Hinge Cover](#)).
 3. Remove the display assembly (see [Removing the Display Assembly](#)).
 4. Remove the keyboard (see [Keyboard](#)).
 5. Remove the palm rest (see [Removing the Palm Rest](#)).
- 🔧 NOTICE:** Handle the speakers with care to help prevent damage to them.
6. Disconnect the speaker cable connector from the system board and remove the two M2.5 x 5-mm screws from the speakers (one on each side).

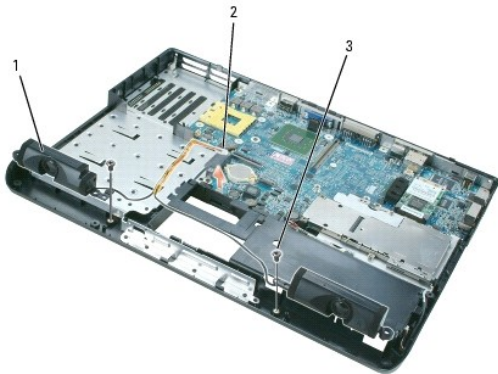

1	speakers (2)	2	speaker cable connector	3	M2.5 x 5-mm screws (2)
---	--------------	---	-------------------------	---	------------------------

7. Remove the speaker cable from the routing clips and remove the speakers.

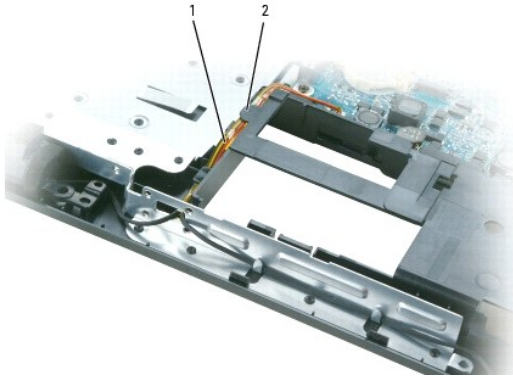

1	cable routing clip	2	speaker cable		
---	--------------------	---	---------------	--	--

Replacing the Speakers

1. Route the speaker cable back through the routing clips and connect the speaker cable connector to the system board.
 2. Align the speakers on the screw holes for securing the speakers to the computer base.
 3. Replace the two M2.5 x 5-mm screws to secure the speakers in place (one on each speaker).
-

[Back to Contents Page](#)

System Board

Dell™ Inspiron™ 6400/E1505 Service Manual

- [Removing the System Board](#)
- [Replacing the System Board](#)

Removing the System Board

⚠ CAUTION: Before you begin the following procedure, follow the safety instructions in the Product Information Guide.

🔌 NOTICE: To avoid electrostatic discharge, ground yourself by using a wrist grounding strap or by periodically touching an unpainted metal surface (such as the back panel) on the computer.

🔌 NOTICE: To help prevent damage to the system board, remove the main battery (see [Before Working Inside Your Computer](#)) before working inside the computer.

The system board's BIOS chip contains the Service Tag, which is also visible on a barcode label on the bottom of the computer. The replacement kit for the system board includes a CD that provides a utility for transferring the Service Tag to the replacement system board.

1. Follow the instructions in [Before Working Inside Your Computer](#).
2. Remove the hard drive (see [Removing the Hard Drive](#)).
3. Remove the optical drive (see [Optical Drive](#)).
4. Remove the memory module(s) (see [Removing the Memory Module\(s\)](#)).
5. Remove the modem (see [Removing the Modem](#)).
6. Remove the Mini-Card (see [Mini-Card](#)).
7. Remove the hinge cover (see [Removing the Hinge Cover](#)).
8. Remove the keyboard (see [Keyboard](#)).
9. Remove the display assembly (see [Removing the Display Assembly](#)).
10. Remove the palm rest (see [Removing the Palm Rest](#)).

🔧 NOTE: It is not required but is highly recommended that you remove the system fan (see [System Fan](#)) to allow easier access to the system board.

11. Remove the video card/thermal-cooling assembly, if present (see [Removing the Video Card/Thermal-Cooling Assembly](#)).
12. Remove the processor thermal-cooling assembly (see [Removing the Processor Thermal-Cooling Assembly](#)).
13. Remove the processor (see [Removing the Processor Module](#)).
14. Remove the ExpressCard/hard-drive bay assembly (see [ExpressCard/Hard-Drive Bay Assembly](#)).
15. Remove the two hex-nut video screws from the back of the computer.

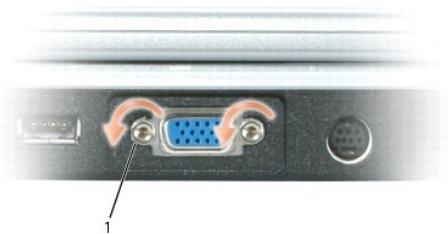

1	hex-nut video screws (2)				
---	--------------------------	--	--	--	--

16. Remove the remaining three M2.5 x 5-mm screws from the system board.



1	M2.5 x 5-mm screws (3)			
---	------------------------	--	--	--

17. Remove the speaker connector along with the internal card with Bluetooth® wireless technology connector.



1	system board	2	speaker connector	3	cable connector for internal card with Bluetooth wireless technology
---	--------------	---	-------------------	---	--

18. Remove the system board, slowly easing the connectors out of their access holes on the back and side of the computer base:
- With the back of the computer facing you, grasp the upper-right corner of the system board and lift it slightly.
 - Pull the system board assembly away from you toward the front of the computer and slightly to the right; at the same time, use your left hand to release the audio connectors by pulling the side of the computer base slightly to the left.

Replacing the System Board

1. Perform all of the steps in [Removing the System Board](#) in reverse order.

NOTICE: Before turning on the computer, replace all screws and ensure that no stray screws remain inside the computer. Failure to do so may result in damage to the computer.

2. Turn on the computer.

NOTE: If you use a BIOS update program CD to flash the BIOS, press <F12> before inserting the CD so that you can set up the computer to boot from a CD this one time only. Otherwise, you must enter the system setup program to change the default boot order.



3. Insert the flash BIOS update program CD that accompanied the replacement system board into the optical drive. Follow the instructions that appear on the screen. See [Flashing the BIOS](#) for further information.
4. Enter the system setup program to update the BIOS on the new system board with the computer Service Tag.
-

[Back to Contents Page](#)

[Back to Contents Page](#)

Dell™ Inspiron™ 6400/E1505 Service Manual

Notes, Notices, and Cautions

-  **NOTE:** A NOTE indicates important information that helps you make better use of your computer.
 -  **NOTICE:** A NOTICE indicates either potential damage to hardware or loss of data and tells you how to avoid the problem.
 -  **CAUTION:** A CAUTION indicates a potential for property damage, personal injury, or death.
-

Abbreviations and Acronyms

For a complete list of abbreviations and acronyms, see "Glossary" in the *Owner's Manual*.

If you purchased a Dell™ n Series computer, any references in this document to Microsoft® Windows® operating systems are not applicable.

Information in this document is subject to change without notice.
© 2006 Dell Inc. All rights reserved.

Reproduction in any manner whatsoever without the written permission of Dell Inc. is strictly forbidden.

Trademarks used in this text: *Dell*, the *DELL* logo, and *Inspiron* are trademarks of Dell Inc.; *Microsoft* and *Windows* are registered trademarks of Microsoft Corporation; *Bluetooth* is a registered trademark owned by Bluetooth SIG, Inc. and is used by Dell under license.

Other trademarks and trade names may be used in this document to refer to either the entities claiming the marks and names or their products. Dell Inc. disclaims any proprietary interest in trademarks and trade names other than its own.

Model PP20L

February 2006 Rev. A00

[Back to Contents Page](#)

Video Card/Thermal-Cooling Assembly

Dell™ Inspiron™ 6400/E1505 Service Manual

- [Removing the Video Card/Thermal-Cooling Assembly](#)
- [Replacing the Video Card/Thermal-Cooling Assembly](#)

 **NOTE:** A removable video card is optional and present only if ordered by the customer. Standard video is integrated on the system board and is not customer removable.

Removing the Video Card/Thermal-Cooling Assembly

 **CAUTION:** Before you begin the following procedure, follow the safety instructions in the Product Information Guide.

- **NOTICE:** To avoid electrostatic discharge, ground yourself by using a wrist grounding strap or by periodically touching an unpainted metal surface (such as the back panel) on the computer.
- **NOTICE:** To help prevent damage to the system board, remove the main battery (see [Before Working Inside Your Computer](#)) before working inside the computer.

1. Follow the instructions in [Before Working Inside Your Computer](#).
2. Remove the hinge cover (see [Removing the Hinge Cover](#)).
3. Remove the keyboard (see [Keyboard](#)).
4. Remove the display assembly (see [Removing the Display Assembly](#)).
5. Remove the palm rest (see [Removing the Palm Rest](#)).

 **NOTE:** Remove the video card/thermal-cooling assembly as a single unit. Do not separate the thermal-cooling assembly from the video card.

6. Remove the video card/thermal-cooling assembly:
 - a. Loosen the two captive screws that secure the video card/thermal-cooling assembly and remove it from the system board.

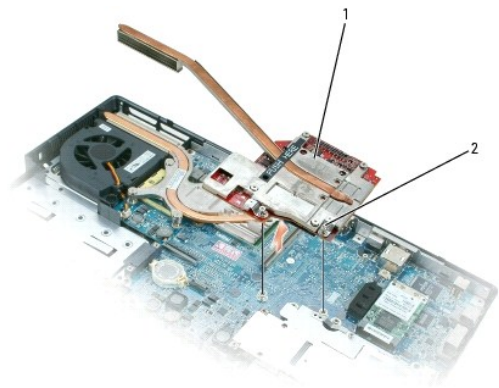

1	video card/thermal-cooling assembly	2	captive screws (2)		
---	-------------------------------------	---	--------------------	--	--

Replacing the Video Card/Thermal-Cooling Assembly

1. Carefully align the video card/thermal-cooling assembly over the connector on the system board and press down.

 **NOTE:** The video card/thermal-cooling assembly is labeled "PUSH HERE."

2. Tighten the two captive screws on the video card/thermal-cooling assembly.
-

[Back to Contents Page](#)